

TECHNICAL INFORMATION FOR KE-SERIES

ELIGAR

an ISO9001/14001 company

Technical Information for GS Oxygen Sensor KE-Series

The GS Oxygen Sensor KE-Series is a unique galvanic cell type oxygen sensor which provides a linear output voltage signal relative to percent oxygen present in a particular atmosphere. The sensor features long life expectancy, excellent chemical durability, and it is not influenced by CO₂, making it ideal for oxygen monitoring.



| | <u>Page</u> |
|---|-------------|
| Introduction | 2 |
| Basic Information and Specifications | |
| Features..... | 2 |
| Applications..... | 2 |
| Structure and Operating Principle..... | 2 |
| Specifications..... | 2 |
| Absolute Maximum Operating and Storage Conditions..... | 3 |
| Dimensions..... | 3 |
| Manufacturing Code Number..... | 4 |
| Typical Sensitivity Characteristics | |
| Sensitivity to Oxygen..... | 4 |
| Response Speed..... | 4 |
| Influence from Various Gases..... | 4 |
| Effects of Pressure Change..... | 5 |
| Humidity Dependency..... | 5 |
| Temperature Dependency..... | 6 |
| Reliability | |
| Influence of Organic Solvents..... | 6 |
| Life Expectancy..... | 6 |
| Relationship of Expected Life and O ₂ Concentration..... | 6 |
| Relationship of Expected Life and Storage Temperature..... | 6 |
| Long Term Stability..... | 7 |
| Handling Instructions | 7 |
| Warranty | 9 |

1. Introduction

The GS Oxygen Sensor KE series (KE-25 and KE-50) is a unique galvanic cell type oxygen sensor which was developed in Japan in 1985. Its most notable features are a long life expectancy, excellent chemical durability, and it is not influenced by CO₂. The KE series oxygen sensor is ideal to meet the ever-increasing demand for oxygen monitoring in various fields such as combustion gas monitoring, the biochemical field, medical applications, domestic combustion appliances, etc.

2. Basic Information and Specifications

2-1 Features

- * Long life (KE-25 - 5 years / KE-50 - 10 years)
- * Virtually no influence from CO₂, CO, H₂S, NO_x, H₂
- * Low cost
- * Operates in normal ambient temperatures
- * Stable output signal
- * No external power supply required for sensor operation
- * No warm-up time is required

2-2 Applications

- * Medical - Anesthetic instruments, respirators, oxygen-enrichers
- * Biotechnology - Oxygen incubators
- * Food industry - Refrigeration, greenhouses
- * Safety - Air conditioners, oxygen detectors, fire detectors

2-3 Structure and operating principle

The KE series sensor is a lead-oxygen battery which incorporates a lead anode, an oxygen cathode made of gold, and a weak acid electrolyte. Oxygen molecules enter the electrochemical cell through a non-porous fluorine resin membrane and are reduced at the gold electrode with the acid electrolyte. The current which flows between the electrodes is proportional to the oxygen concentration in the gas mixture being measured. The terminal voltages across the thermistor (for temperature compensation) and resistor are read as a signal, with the change in output voltages representing the change in oxygen concentration.

The following chemical reactions which take place in KE sensors:

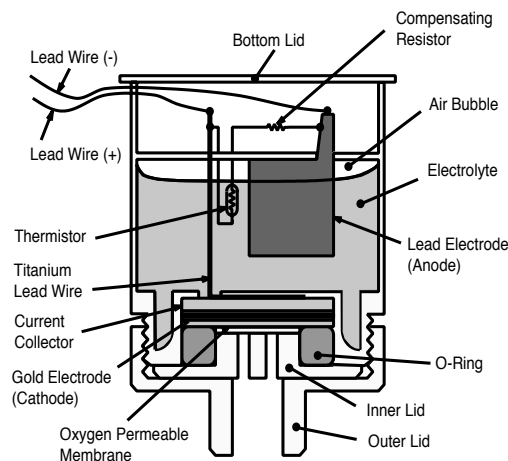
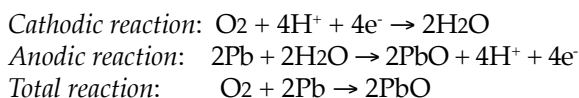

Fig. 1 - Structure of KE-25/KE-50

A small volume air bubble is contained inside the sensor body in order to compensate for internal influence from pressure changes. The sensor's electrolyte is primarily composed of acetic acid with a pH of approximately 6. The sensor's body is made of ABS resin.

Both the KE-25 and the KE-50 sensors are based on identical design and performance principles. The basic difference between these two models is in the thickness of the fluorine resin membrane. This affects the diffusion speed of oxygen molecules and, as a result, the response speed and life of the sensor. Each model shows basically the same performance in the various conditions described in the technical data, e.g. influence by other gases, pressure dependency, etc.

2-4 Specifications

Table 1 (see following page) shows the specifications of the KE series oxygen sensors.

Notes:

- 1) When calibrated at both 0% and 100% of O₂, accuracy in the range from 0-100% O₂ shall be within ±1% of full scale for KE-25 and ±2% of full scale for KE-50.
- 2) V_a = output voltage at 21% O₂
V₀ = output voltage at 0% O₂
V₁₀₀ = output voltage at 100% O₂
- 3) V_a = output voltage at 25°C
V_H = output voltage at 40°C
V_L = output voltage at 5°C
- 4) Sensors should be used under conditions where the air exchange is greater than 200~300ml per minute in order to obtain the response speed as specified in Table 1.

TECHNICAL INFORMATION FOR KE-SERIES

| Item | Model | |
|---|--|--------------------------------|
| | KE-25 | KE-50 |
| Measurement range | 0~100% O ₂ | |
| Accuracy (Note 1) | ±1% (full scale) | ±2% (full scale) |
| Operating conditions | Atmospheric pressure | 811hPa ~1216hPa |
| | Temperature | 5~40°C |
| | Relative humidity | 10 ~ 90%R.H. (no condensation) |
| Response time (90%) (Note 4) | 14±2 seconds | 60±5 seconds |
| Initial output voltage under standard test conditions | 10.0~15.5mV | 47~65mV |
| Standard test conditions | Test gas | 21% O ₂ |
| | Atmospheric pressure | 1013±5hPa |
| | Temperature | 25°C±1°C |
| | Relative humidity | 60±5% |
| Linearity | (V _a -V ₀)/(V ₁₀₀ -V ₀) (Note 2) | 0.21±0.02 |
| Offset voltage | V ₀ | ≤0.5mV ≤6.0mV |
| Temperature characteristics (Note 3) | V _H /V _a | 0.91~1.09 |
| | V _L /V _a | 0.91~1.09 |

Table 1 - Specifications of KE-25/KE-50

2-5 Absolute maximum operating and storage conditions

The accumulated total duration of exposure to the absolute maximum conditions listed in Table 2 should be limited to no more than 24 hours.

Cautions:

1) Beneath the lower pressure limit, sensor life may

| Item | Lower limit | Upper limit |
|-------------------|-----------------|------------------|
| Pressure | 507hPa (Note 1) | 1520hPa (Note 2) |
| Temperature | -20°C (Note 3) | 60°C (Note 4) |
| Relative humidity | 0%RH (Note 5) | 100%RH |

Table 2 - Absolute maximum operating and storage conditions of KE-25/KE-50

become shorter due to excessive evaporation of the liquid electrolyte.

2) At pressure in excess of the upper limit, sensor output may become unstable due to excessive air entering through the o-ring.

3) Below -20°C, the electrolyte will freeze and the sensor will not function. KE sensors are not damaged by freezing of the electrolyte and will resume functioning after the electrolyte thaws to a liquid state.

4) At temperatures in excess of the upper limit, the ABS resin casing may deteriorate.

5) If used for a long period in an extremely dry environment, sensor life may be shortened due to excessive evaporation of the liquid electrolyte.

2-6 Dimensions (see Fig. 2)

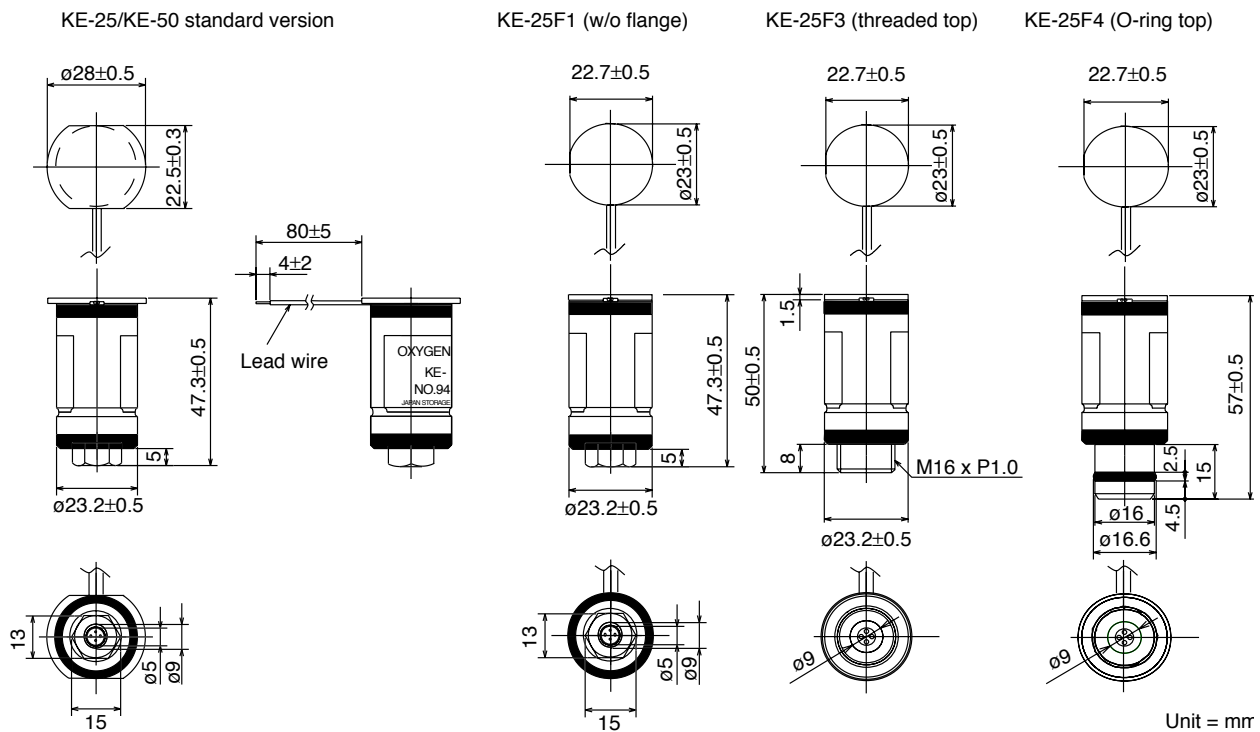

Figure 2 - Dimensions of KE-25/KE-50

2-7 Manufacturing code number

The manufacturing code number shown on the side of the sensor body indicates the manufacturing Year/ Month/Lot No. (since September 1990).

Example: 02 09 01
 ↑ ↑ ↑
 Year Month Lot No.
 2002 Sept. 01

3. Typical Sensitivity Characteristics

3-1 Sensitivity to oxygen

Figures 3a and 3b show the sensitivity characteristics of the KE sensors. The Y-axis indicates the output voltage of the sensor.

3-2 Response time

Figure 4 demonstrates the response pattern of the sensor's output voltage. The Y-axis indicates the output voltage ratio(%) to saturated voltage. Typical response time to 90% of saturated response is 14 seconds for KE-25 and 60 seconds for KE-50.

3-3 Influence of various gases

The influence on KE sensors from various gases is shown in Table 3. The 'interference level' shown in the table indicates the change ratio between sensor output in an air (20.7% O₂) and gas mixture compared to sensor output in normal air (20.7% O₂). For example, if the interference level of SO₂ is considered to be 3%, that would indicate that the sensor's output voltage in normal air (20.7% O₂) would correspond to a concentration of 21.3% O₂ (20.7% x 1.03).

| Gas | Concentration | Interference Level |
|-------------------|---------------|--------------------|
| Carbon monoxide | 0-100% | no effect |
| Carbon dioxide | 0-100% | no effect |
| Nitric monoxide | 0-1% | no effect |
| Nitrogen dioxide | 0-1% | no effect |
| Sulfur dioxide | 0-3% | 3% |
| Hydrogen sulfide | 0-3% | no effect |
| Ammonia | 0-3% | 1% |
| Hydrogen | 0-100% | no effect |
| Hydrogen chloride | 0-3% | 1% |
| Benzene | 0-100ppm | 1% |
| Methane | 0-100% | no effect |

Table 3 - Influence of various gases on KE-series sensors

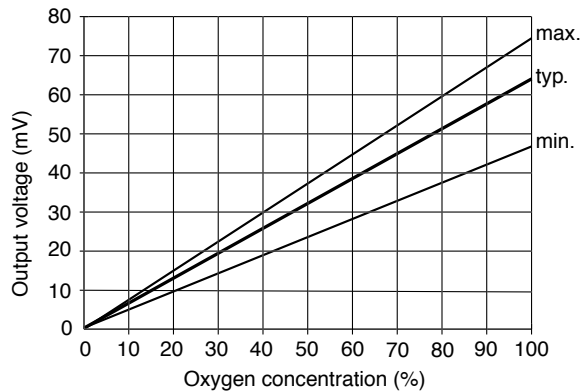

Fig. 3a - KE-25 sensitivity characteristics

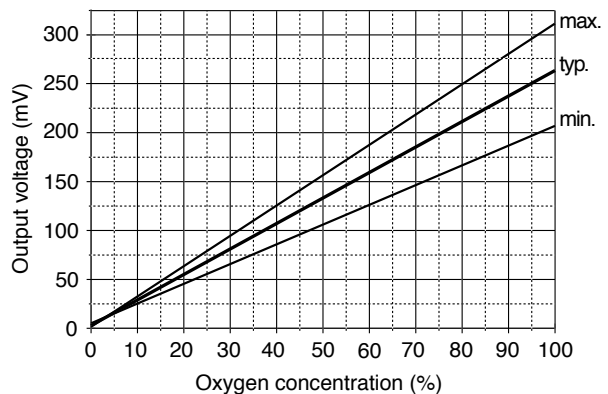

Fig. 3b - KE-50 sensitivity characteristics

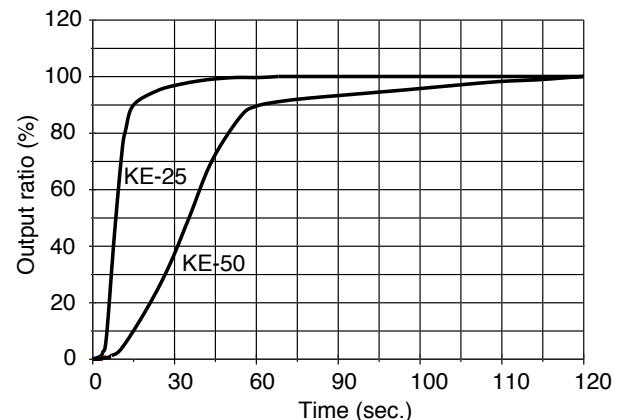

Fig. 4 - Response speed of KE sensors to oxygen

3-4 *Effects of pressure change*

The pressure dependency of KE-50 can be seen in Figure 5. In this range of atmospheric pressure, sensor output voltage maintains a linear relationship when compared with atmospheric pressure. This same tendency can be seen in all models of KE sensors.

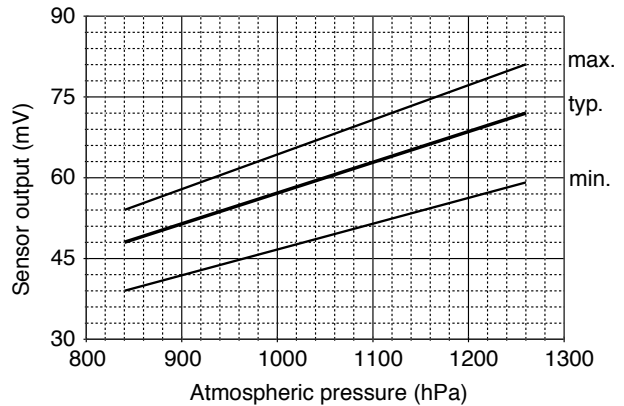

Fig. 5 - KE-50 response of output voltage to ambient pressure changes (at 25°C/60%RH)

3-5 *Humidity dependency*

Figure 6 displays an example of humidity dependency for KE-50. The Y-axis shows sensor output voltage. The sensor itself is not influenced by humidity, but its output voltage may show some variation to the extent that O₂ is displaced by humidity, as indicated in Figure 7.

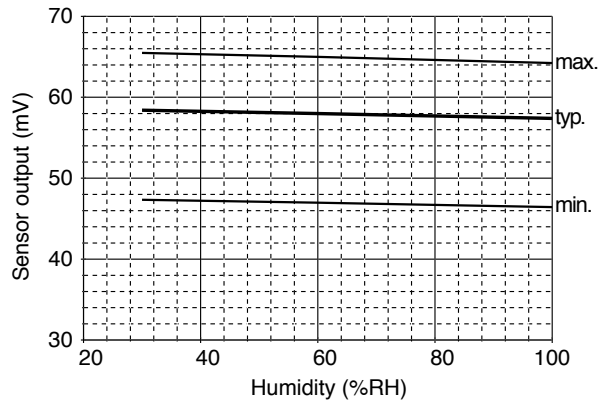

Fig. 6 - KE-50 effect of humidity on output voltage (at 25°C in ambient air)

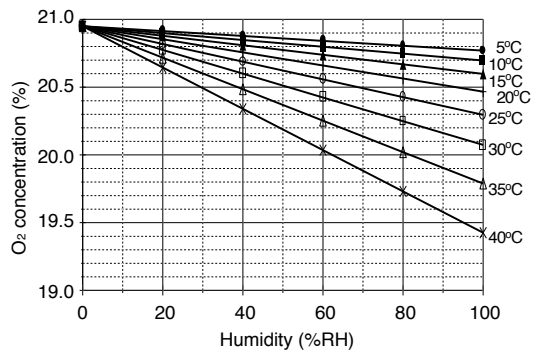

Fig. 7 - Effect of humidity on O₂ concentration

3-6 Temperature dependency

The standard KE sensor has a built-in temperature compensation circuit which uses a thermistor that is mounted inside the sensor's body (see Fig. 1). The temperature dependency of the KE series with this built-in compensation circuit is shown in Figs. 8a and 8b.

The KE sensor may show some transient characteristics if the ambient temperature changes very widely and quickly. This is caused by the difference in response speed to temperature changes between the sensor compartment and the built-in thermistor. A quick rise in ambient temperature temporarily makes output voltage high and vice versa for a quick fall in temperature. Such temporary drift disappears after the sensor's temperature reaches equilibrium with the ambient temperature. For avoiding this problem, the sensor should be protected from quick temperature changes (such as direct exposure to sunlight or wind) by some kind of enclosure.

In addition, temperature should be kept uniform throughout the sensor's structure in order to avoid improper compensation caused by differences in temperature between the sensing area and the thermistor location.

4. Reliability

4-1 Influence of organic solvents

Exposure to organic solvents such as toluene, benzene, xylene, acetone, methyl ethyl ketone, methyl chloride, kerosene, gasoline, naphtha and gas oil may cause the sensor's external housing (ABS resin) to degenerate and degrade, resulting in unstable output voltage. Condensation of such solvents on the sensor would cause adverse influence on output voltage and response speed. To reduce potential risk of exposure to these solvents, installation of a filter or condenser on the sensor is recommended.

4-2 Life expectancy

The life expectancy of the KE oxygen sensor is expressed in %-hours as follows:

$$[\text{Oxygen Concentration (\%)}] \times [\text{Exposure Time (hours)}]$$

Accordingly, the life of KE-50 is approximately 1,800,000 %-hours, and the KE-25 is 900,000 %-hours. The end of life for KE sensors is specified as the point at which output voltage is reduced to 70% from the initial

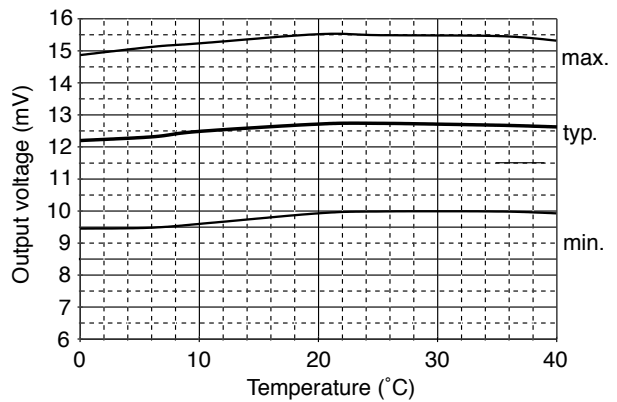

Fig. 8a - KE-25 temperature dependency of output voltage

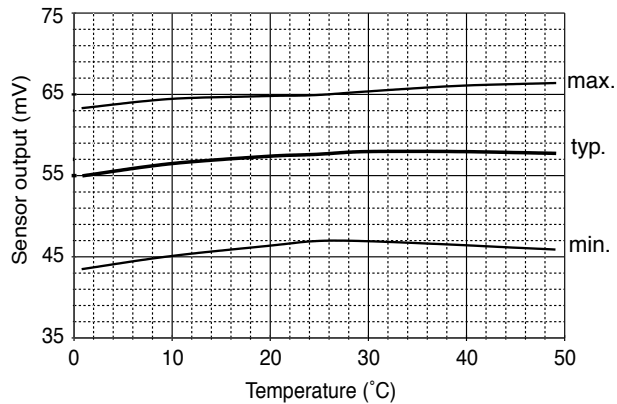

Fig. 8b - KE-50 temperature dependency of output voltage

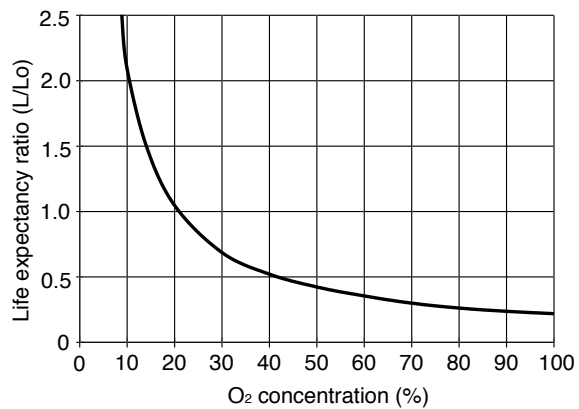

Fig. 9a - Relationship of life expectancy vs. O₂ concentration (Lo = life at 20.7% O₂)

output voltage of the sensor. These facts indicate that the expected life time in ambient conditions (21% O₂ at 20°C) is 10 years for KE-50 and 5 years for KE-25.

a) *Relationship between expected life and O₂ concentration*

Figure 9a shows the relationship between life expectancy and O₂ concentration for KE sensors. The Y-axis indicates the ratio of life expectancy in a given O₂ concentration (L) to life expectancy in natural air (L₀). The greater the O₂ concentration, the shorter the life expectancy. The influence of atmospheric pressure on life expectancy is estimated based on the O₂ concentration in a given atmospheric pressure.

b) *Relationship between expected life and storage temperature*

Figure 9b shows the relationship between life expectancy and ambient temperature. The Y-axis indicates the ratio of life expectancy at a given temperature (L) compared to life expectancy at 20°C (L₀). A correlation exists between the sensor's life time and its storage temperature—the life time becomes shorter as the storage temperature increases.

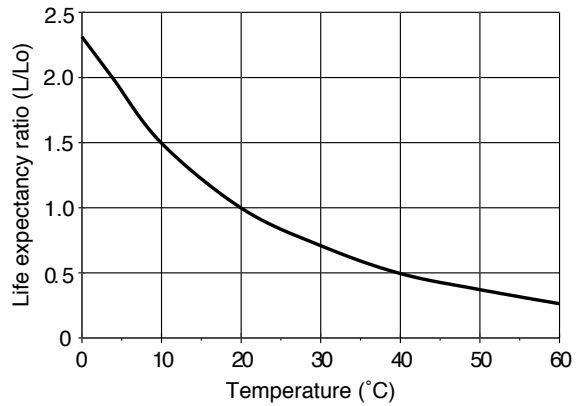

Fig. 9b - Relationship of life expectancy vs. temperature (L₀ = life at 20°C)

4-3 *Long term stability*

When used in normal air without any incidence of improper use, both KE-25 and KE-50 show good long term characteristics as illustrated in Figs. 10a and 10b (see previous page).

Please note that there are various factors which may influence the life time of KE oxygen sensors in actual use and that their life span can be variable.

5. Handling Instructions

5-1 *Required oxygen amount*

KE sensors consume a small amount of oxygen during the detection process. It is recommended that these sensors be used under conditions where the air exchange is greater than 2~3ml per minute to offset the sensor's oxygen consumption. Please note that sensors should be used under conditions where the air exchange is greater than 200~300ml per minute in order to obtain response speed specified in Table 1.

5-2 *Mechanical strength against shock and vibration*

Since mechanical shock and vibration may potentially influence the sensitivity characteristics of the sensor, these factors should be avoided in actual usage. Temporary changes/instability in the sensor's output signal may result due to these factors, but the signal may recover to its original state after the sensor is

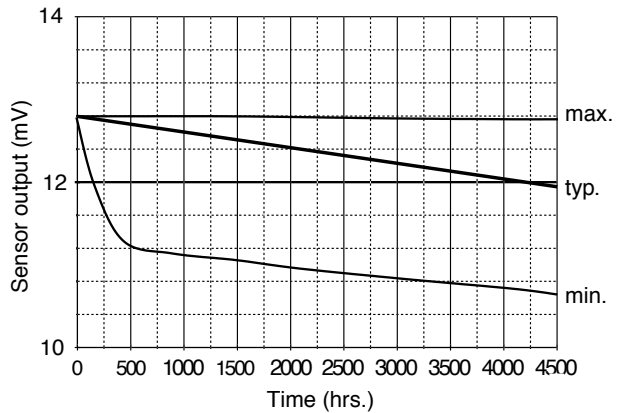

Fig. 10a - KE-25 long term stability

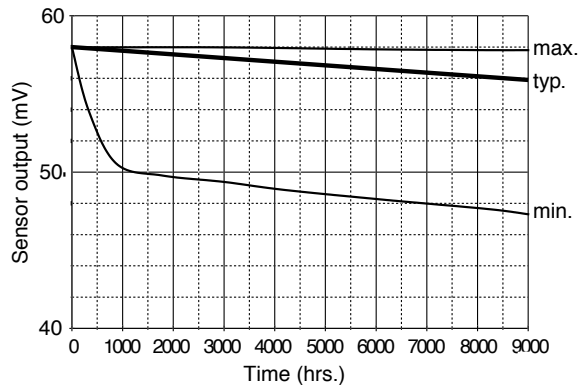

Fig. 10b - KE-50 long term stability

kept motionless in natural air/room temperature for between several hours to several days. If the mechanical shock or vibration is great, an irreversible change in the output signal may occur due to structural damage within the sensor. Shock absorbing measures should be used to protect the sensor during transportation or when used for applications in which shock/vibration is likely to occur.

5-3 Position dependency

At all times the sensor is recommended to be kept either horizontal or in the normal vertical position (refer to side view in Figure 2) in order to prevent the cathode from drying out. If this were to occur, the sensor's output signal would fluctuate.

5-4 Low O₂ concentration detection

When less than 1% O₂ is measured, offset voltage (which appears at close to 0% of O₂) should be taken into consideration when calculating O₂ concentration. For details, please refer to the document *Application Notes on Offset Voltage and Low Concentration Measurement*.

5-5 Storage conditions

To prolong the life expectancy of KE sensors, storage at low temperature (in a refrigerator) and at low oxygen concentration is recommended. Care should also be taken to ensure that the lead wires are not connected or shorted during storage as this may cause slow response to oxygen.

If the sensor is stored in a 0% O₂ environment for an extended period of time, the sensor's offset voltage (see Sec. 5-4) becomes lower and response speed to O₂ will become slower. In this case, the sensor will be able to recover to normal response speed after exposure to a normal environment for a period of 24 hours.

The absolute minimum storage temperature for the sensor is -20°C. Below this temperature, the electrolyte will freeze. KE sensors are not damaged by the freezing of the electrolyte, and they can be used again after the electrolyte melts.

The specified maximum storage temperature is 60°C. This is a result of the temperature limitation of ABS resin, the material which is used to make the sensor's body.

5-6 Influence of condensation

Measures should be taken to prevent condensation on the sensor because the output signal will degrade

and response speed will decrease, causing inaccurate measurement. However, once condensation dissipates, sensor characteristics will recover to their original state.

5-7 Recommended input impedance

The sensor must be connected to equipment which has an input impedance of 1000kΩ or greater. If not, proper temperature compensation would not be possible.

5-8 Sensor connection

The sensor must not have a counter-electromotive force applied to it from any equipment to which it is connected. Application of external electric potential to the sensor's output terminals may cause temporary instability in the output signal and reduced response speed. However, removal of this condition and subsequent aging in normal air for several days will allow the sensor to recover to normal.

If reverse polarity or excessive voltage is applied to the sensor, the characteristic change would be irreversible due to the internal electrical damage caused by this condition. For example, if several 10mV of reverse voltage were applied, the internal electrode would be broken.

5-9 Disassembly or repair of the sensor

Disassembling or repair of the sensor should be avoided because it will result in a change of sensitivity characteristics. The reason for such a change is related to the sensor's structure. The most important factor in determining sensitivity is the condition of the cathode which is determined by affixing the F.E.P. membrane with a suitable pressure via tightening the plastic top. Loosening of the plastic top will change the internal pressure and therefore change the sensor's sensitivity.

The plastic label covering the sensor's housing should not be removed since the label is used as a seal to fasten and immobilize the plastic top on the sensor's body.

5-10 Safety measures for electrolyte leakage

If the liquid electrolyte leaks due to sensor breakage, care should be taken in handling the sensor, which should immediately be placed into a plastic bag. The liquid electrolyte is a weak aqueous acid solution (pH=5~6) with an irritating odor. The liquid is non-flammable. Since this solution contains lead acetate,

which is harmful to humans, contact with this liquid should be avoided.

In case the liquid electrolyte contacts the skin or clothing, wash with soapy water and rinse generously with plain water. If the liquid electrolyte contacts the eye, flush with water for at least 15 minutes and obtain immediate medical assistance. In case of breathing in of the electrolyte, flush the nasal cavity thoroughly with water and seek immediate medical assistance. If the electrolyte is swallowed, rinse the mouth thoroughly with water and seek immediate medical assistance.

6. Warranty

Sensors shall be warranted to meet the specifications shown in Table 1 for a period of one year after the date of purchase from Figaro.

Figaro USA Inc. and the manufacturer, Figaro Engineering Inc. (together referred to as Figaro) reserve the right to make changes without notice to any products herein to improve reliability, functioning or design. Information contained in this document is believed to be reliable. However, Figaro does not assume any liability arising out of the application or use of any product or circuit described herein; neither does it convey any license under its patent rights, nor the rights of others.

Figaro's products are not authorized for use as critical components in life support applications wherein a failure or malfunction of the products may result in injury or threat to life.

FIGARO GROUP

HEAD OFFICE

Figaro Engineering Inc.
1-5-11 Senba-nishi
Mino, Osaka 562 JAPAN
Tel.: (81) 72-728-2561
Fax: (81) 72-728-0467
email: figaro@figaro.co.jp
www.figaro.co.jp

OVERSEAS

Figaro USA Inc.
3703 West Lake Ave. Suite 203
Glenview, IL 60026 USA
Tel.: (1) 847-832-1701
Fax.: (1) 847-832-1705
email: figarousa@figarosensor.com
www.figarosensor.com